

# Cargo Bar & Shoring Beam

# RB

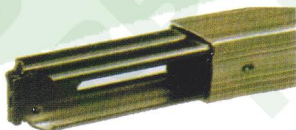

**End Stud**  
19,24mm & Slotted



**A6001**  
19mm/3/4"



**A6002**  
24mm



**Alum. Decking Beam,**

with steel insert by 3 or 4 mm, extend 12"/300mm max.

Thickness 3mm WLL 2000Lbs/900Kgs in horizontal Load, +/- 10kgs

Thickness 4mm WLL 2500Lbs/1100Kgs in horizontal Load, +/- 10kgs

<b>VR6003</b>	3mm, 85" ~ 97"	<b>VR6007</b>	213~245cm
<b>VR6004</b>	4mm, 85" ~ 97"	<b>VR6008</b>	213~245cm
<b>VR6005</b>	3mm, 90" ~102"	<b>VR6009</b>	238~275cm
<b>VR6006</b>	4mm, 90" ~102"	<b>VR6010</b>	238~275cm



**Round Shoring Bar**

Steel, Galvanized, With 19mm or 24mm End Stud or Slot End Stud. With 1-3/4"/45mm X 4mm Tube, Extend 15"/385mm max. WLL 800Lbs/400kgs max. +/- 8kgs.

<b>VR6011</b>	87"~102"	<b>VR6013</b>	2215-2600mm With 19mm Stud
<b>VR6012</b>	87"~102"	<b>VR6014</b>	2215-2600mm With 24mm Stud
<b>VR6015</b>	2215-2600mm With 11mm Slotted Stud		

\*2"/50mm & 42mm Tube are available, special lengths upon request.

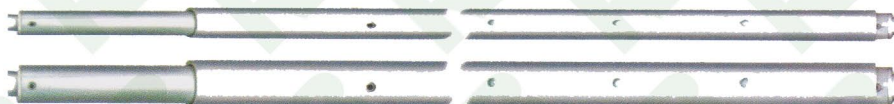

**Square Shoring Bar,**

Steel, Galvanized, with 2"/50mmx2.5mmTube, with 19mm End Stud, Extend 385mm/15", WLL 1000Lbs/500Kgs, +/- 11kgs

<b>VR6016</b>	87"~102"	<b>VR6017</b>	216~255cm
---------------	----------	---------------	-----------



**Alum Cargo Bar With Spring Buffer, 42mm/1.66" Tube,**

extend 380mm/15" max.,with VR03 2"x4" or VR03L 4"x4" Large Rubber Pads

<b>VR6018</b>	90~105", 2"x4" Pads
<b>VR6019</b>	90~105", 4"x4" pads
<b>VR6020</b>	2280~2650mm, with 2"x4" pads
<b>VR6021</b>	2380~2750mm,with 2"x4" pads

4"x4" Pad

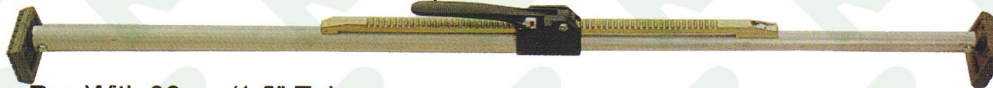

**Alum Cargo Bar With 38mm/1.5" Tube,**

extend 380mm/15" max., with VR03 2"x4" or VR03L 4"x4" Bolt On Rubber Pads

<b>VR6022</b>	90~105", with 2"x4" Pads
<b>VR6023</b>	90~105", with 4"x4" pads
<b>VR6024</b>	2280~2650mm,with 2"x4" pads
<b>VR6025</b>	2380~2750mm,with 2"x4" pads

2"x4" Pad

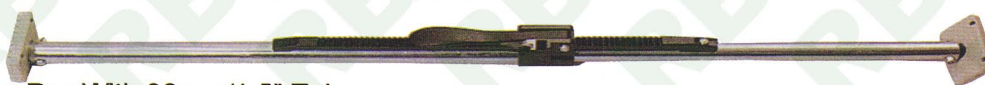

**Steel Cargo Bar With 38mm/1.5" Tube,**

extend 380mm/15" max., with VR03 2"x4" or VR03L 4"x4" Bolt On Rubber Pads

<b>VR6026</b>	90~105", with 2"x4" Pads
<b>VR6027</b>	90~105", with 4"x4" pads
<b>VR6028</b>	2280~2650mm,with 2"x4" pads
<b>VR6029</b>	2380~2750mm,with 2"x4" pads



# Cargo Bar & Alum. Track

# RB

## Jack Bar



Square Jack Bar, 2pcs, Heavy Duty, With 2"/50mm Tube & 4"x4" Bolt On Pads, extend 25"/625mm.  
**VR4001** 87"~112"    **VR4002** Adjusts 80" to 105"



Round Jack Bar, 2pcs, Med. Duty, With 1.5"/38mm tube & 4"x4" Bolt On Pads, extend 25"/625mm  
**VR4003** Adjust 87" to 112"    **VR4004** Adjusts 80" to 105"



**VR4006** Cargo Bar For Pick Up, With Screw Extension Pads, Adjusts 40"~70" or 100~175mm, Shrink Painted



**VR4007** Steel Cargo Bar 1880-2880mm

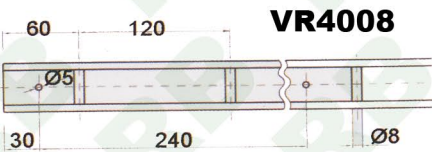
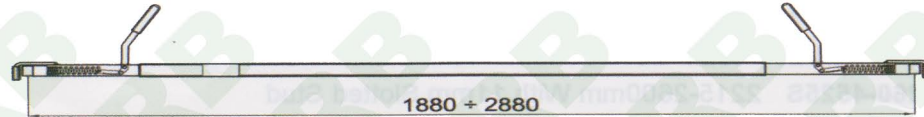

**VR4008** Aluminum Track With Pin



Truck With Rubber

**VR4010** 6m  
**VR4011** 5.74m

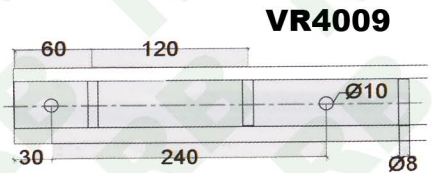

**VR4009**

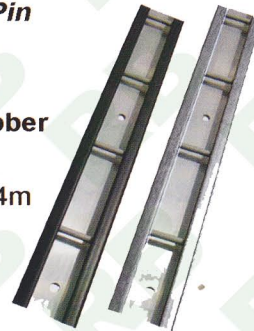

Track Without Rubber

**VR4012** 6m  
**VR4013** 5.74m



**VR4014** Alum Cargo Bar Adjusts To 250cm

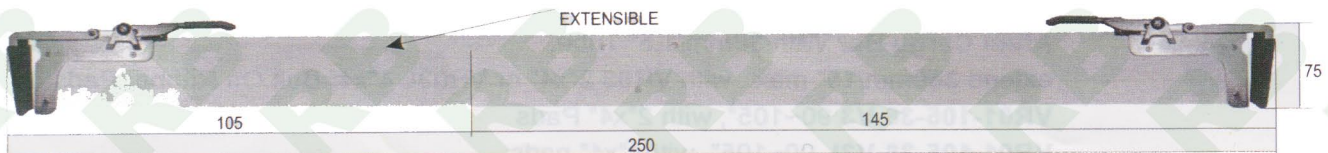

**Dunnage Pack** -Working Pressure At 0.2 Bar / Kpa / 2.9P.S.



**VR4015** 500x1000mm  
**VR4016** 800x1200mm  
**VR4017** 1000x1800mm  
**VR4018** 1000x2000mm  
**VR4019** 1000x2400mm

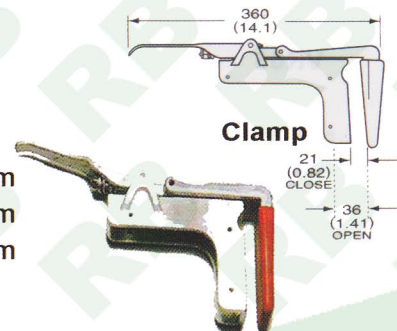



# Cargo Bar & Accessories

# RB

## Hoop Set For Lock Bars VR01,VR07

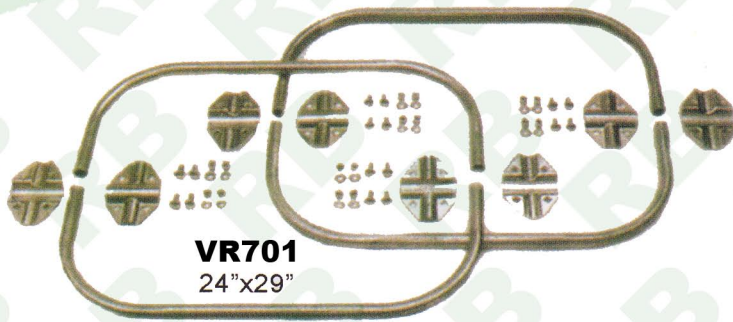

**VR701**  
24"x29"



**VR705**



**VR706**

Large Foot Pad Set 4" x 4"

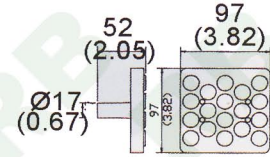

**VR704** Clamp

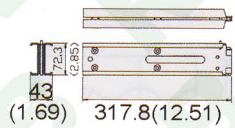
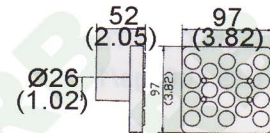

**VR702**

Beam Insert 3mm Thick, 1.7kgs



**VR703**

Beam Insert 4mm Thick, 2.1kgs

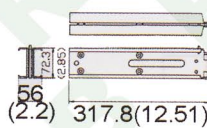

**VR707**

Foot Pad 2"x4"

## Cargo Bar Keeper



**VR708** Regular Body



**VR709**, Reinforced Body

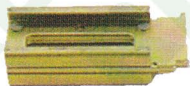

**VR710** Bean Insert, short.

## Rollers For Side Curtain



**A3015**

Waisted Roller - White  
Material: Nylon

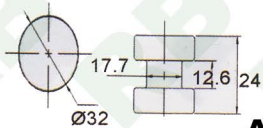

**A3005Y A3005R A3005B**

Waisted Roller - Yellow, Red, Blue  
Material: Nylon

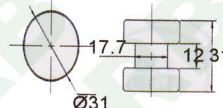

**W3005**

Waist Hook for Roller

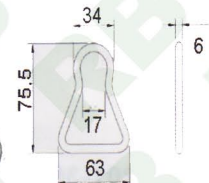

**A3017**

50MM/2" Edge Protector  
Nylon



**A3006**

50mm/2" Edge Protector  
Plastic



**A3007**

50mm/2" Edge Protector  
Length 700mm/27.56"



**W3005**

Waist Hook for Roller

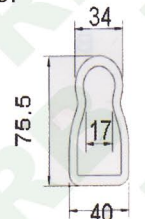

## Webbing Corner Protector



**A3008**



**A3009**



**A3010**



4" With Open End

## Belt Protect Pad



Webbing Protectors

**A3012** 35mm

**A3013** 50mm

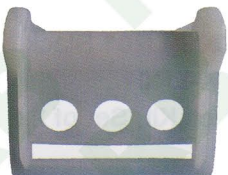

**A3011**

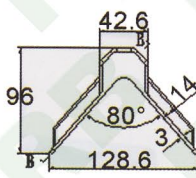
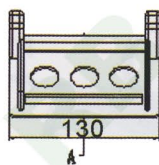

**PB015**, 25mm

Belt Protect Pad  
25mm/1", Black  
PB31-50 2"/50mm



**PB014**, 25mm

Belt Protect Pad  
25mm/1", Black  
PB32-50 2"/50mm